

Sunrise Building (SNR)

Updated 12-12-18

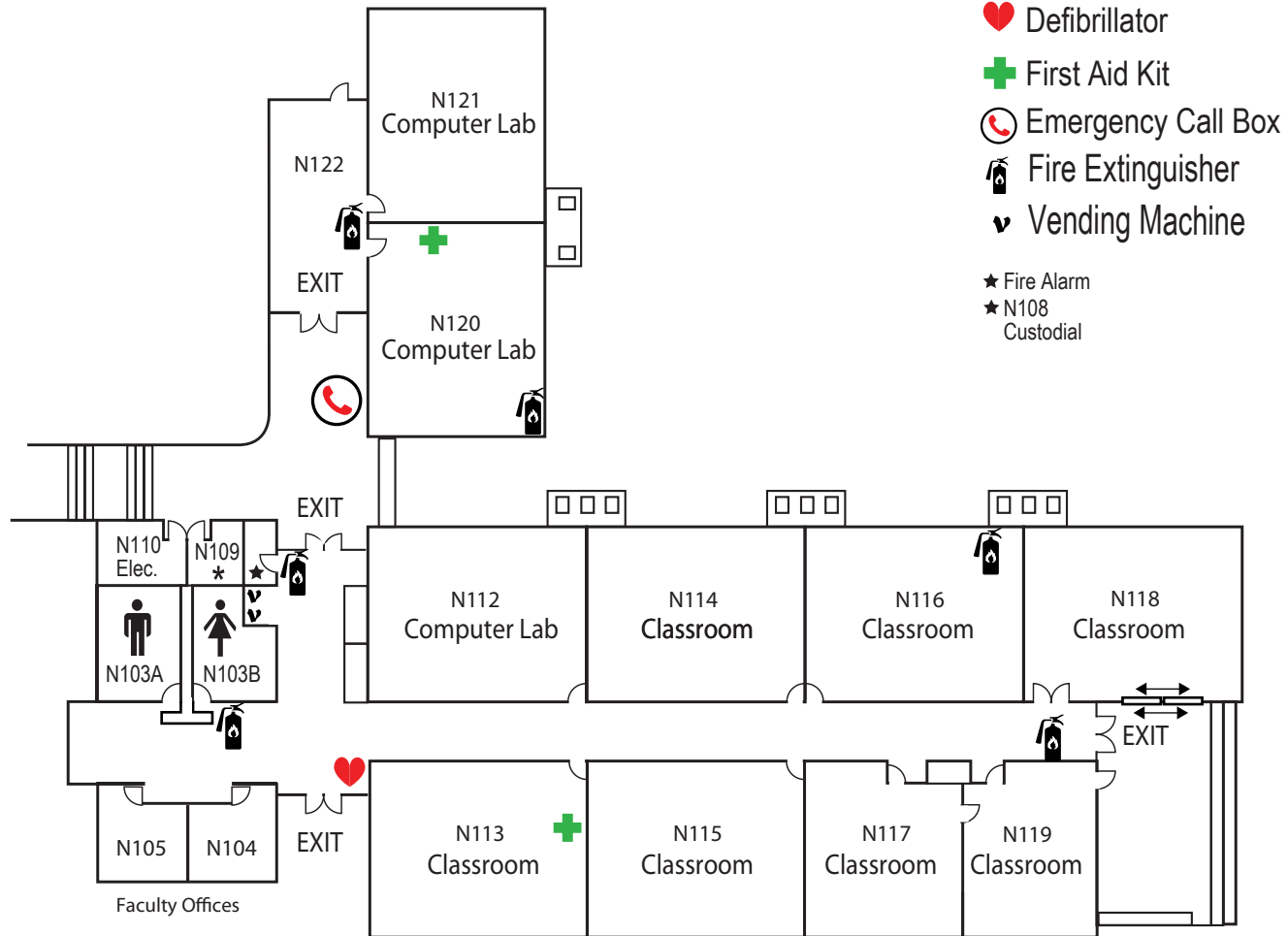

Cascade Building (CAS)



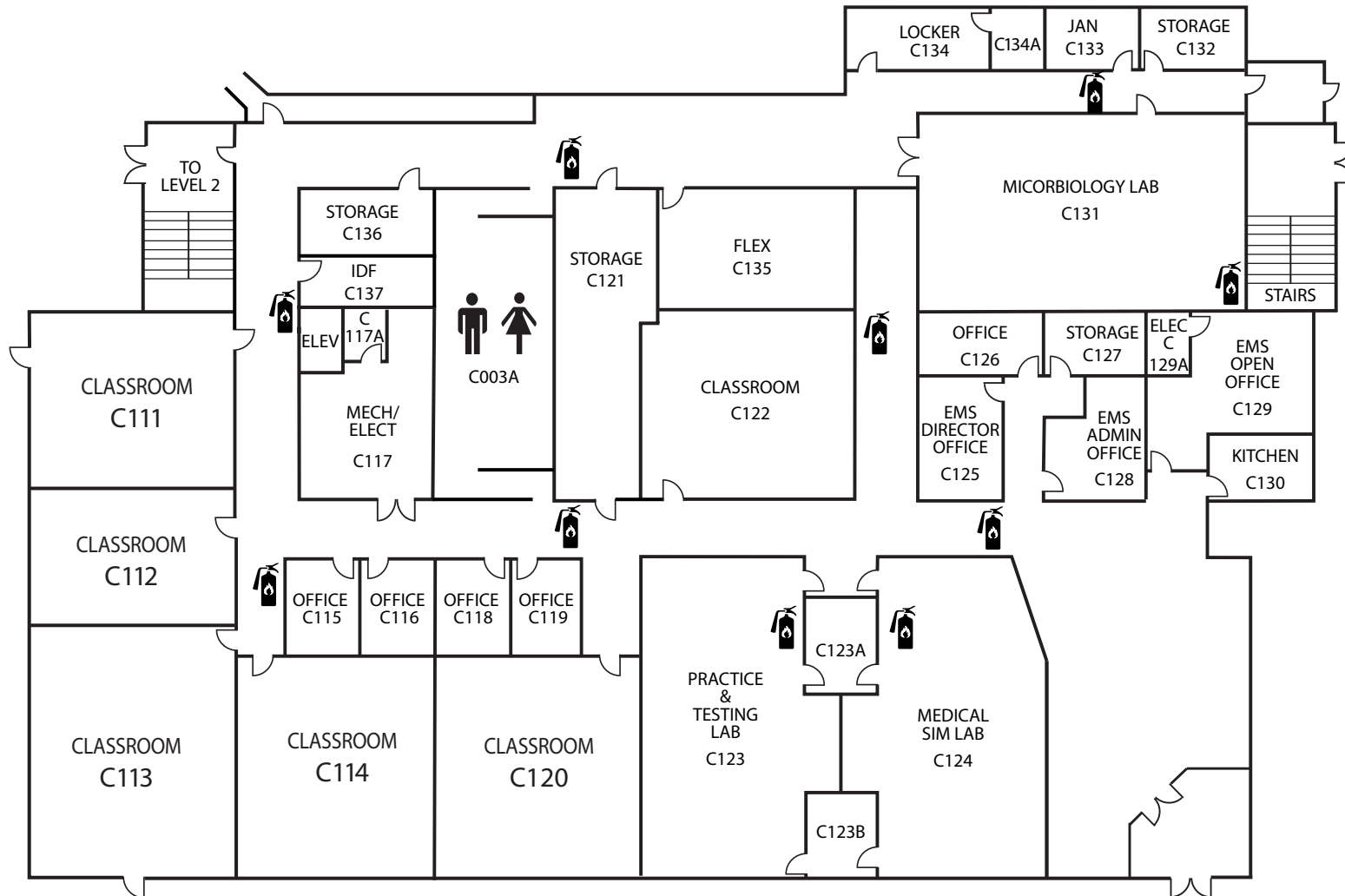

Level 1

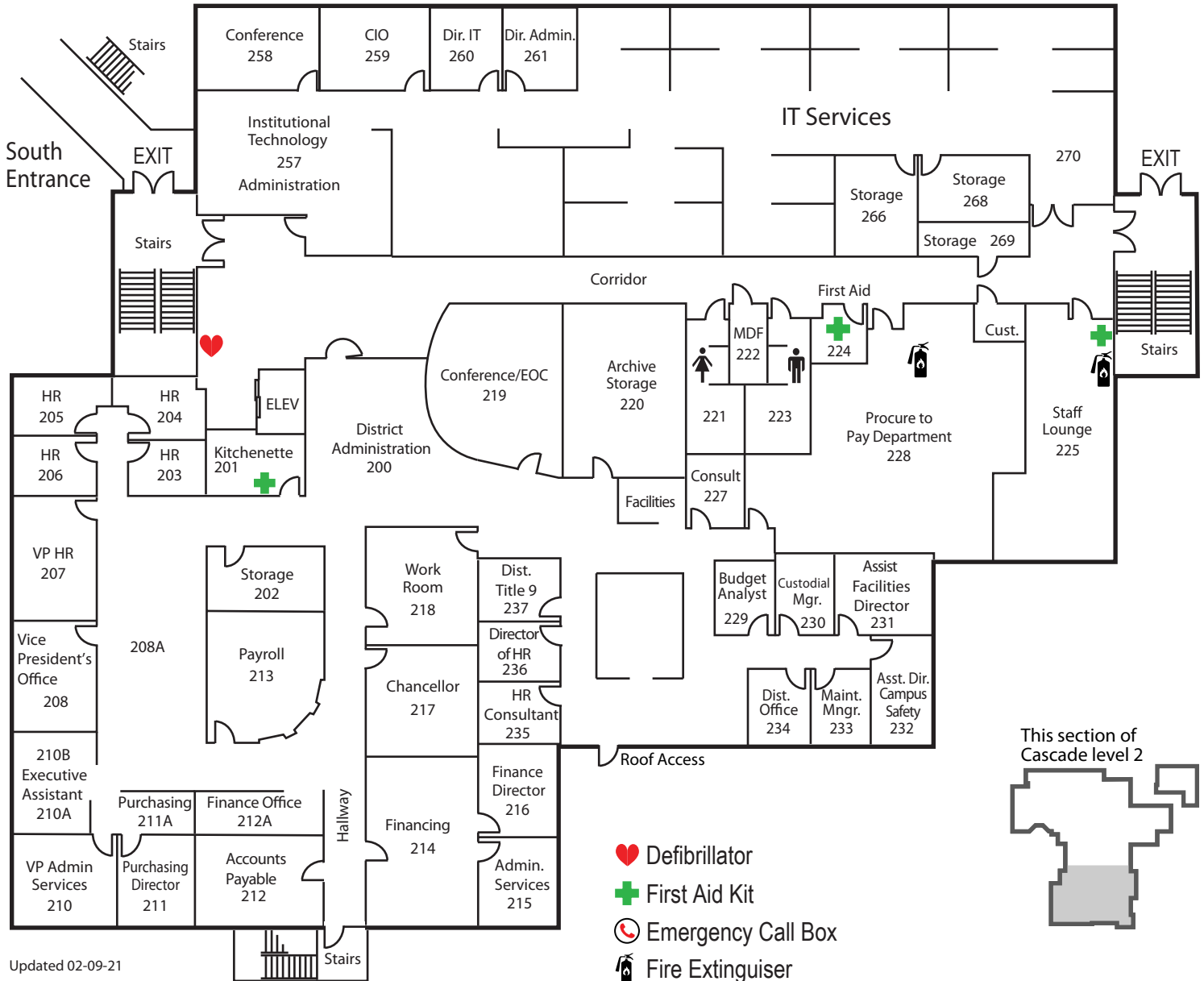
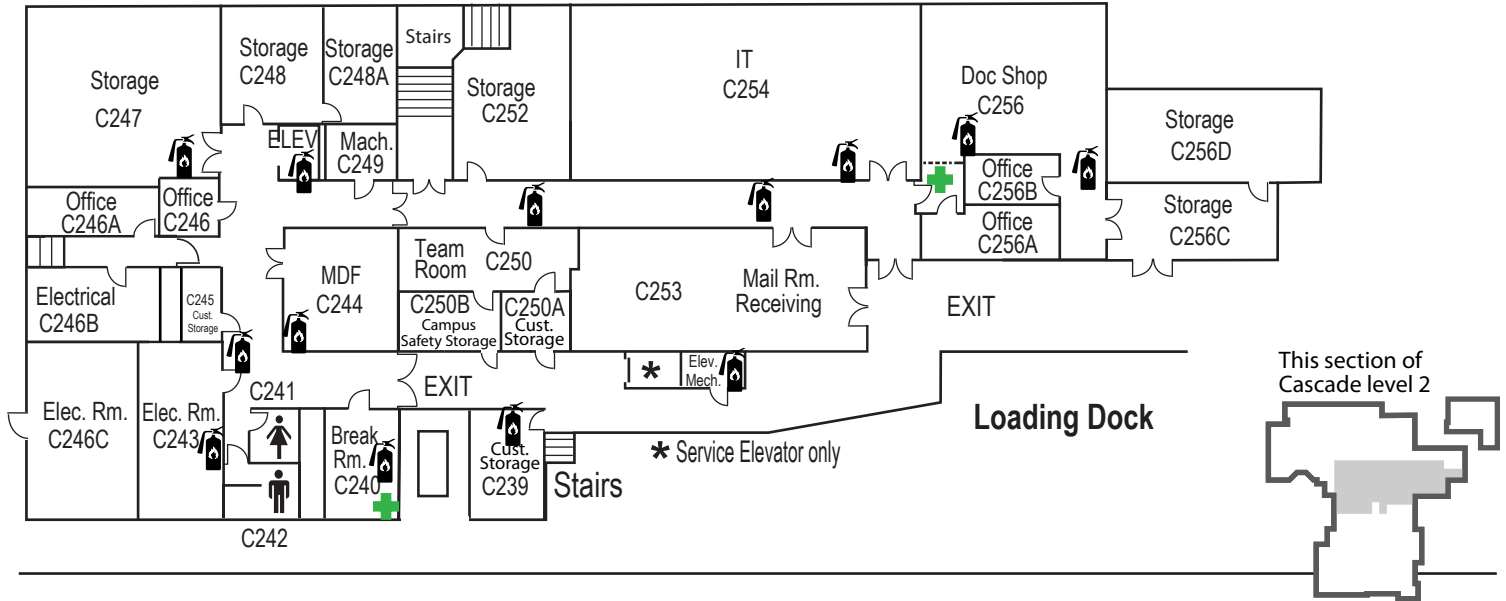

Cascade Building (CAS)

Level 2



-  Defibrillator
-  First Aid Kit
-  Emergency Call Box
-  Fire Extinguisher

Cascade Building (CAS)

Level 3

(Northeast section)

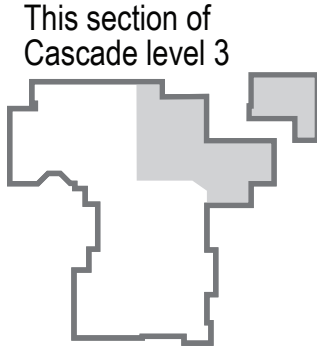
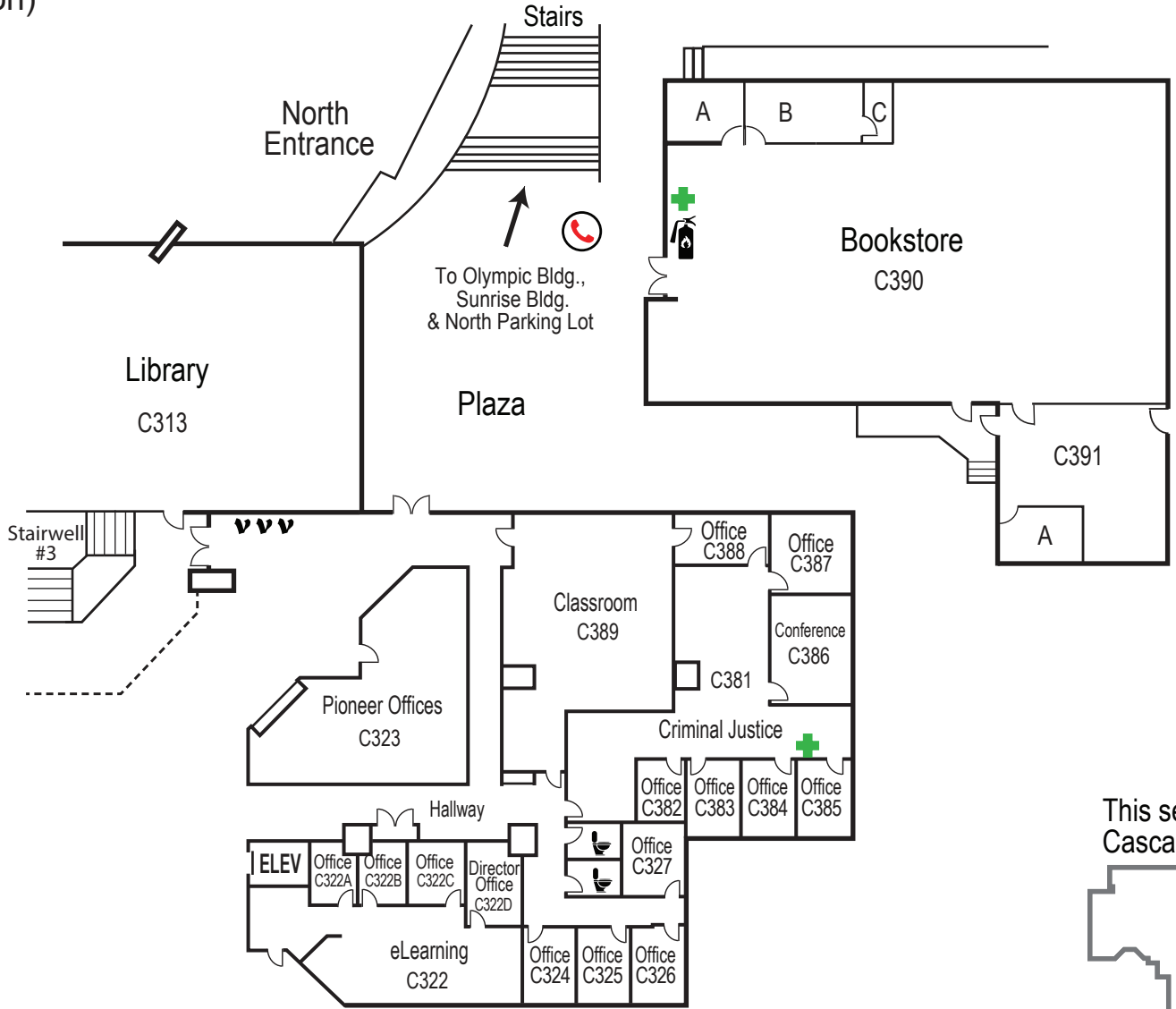

Construction Zones

Defibrillator

First Aid Kit

Emergency Call Box

Fire Extinguisher

All Gender Restroom

Vending Machine

Cascade Building (CAS)

Level 3

(Northwest section)

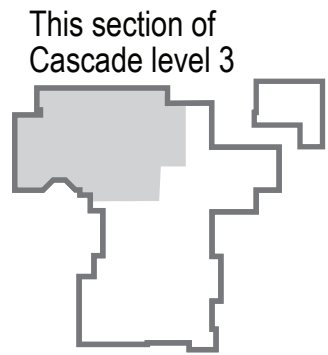
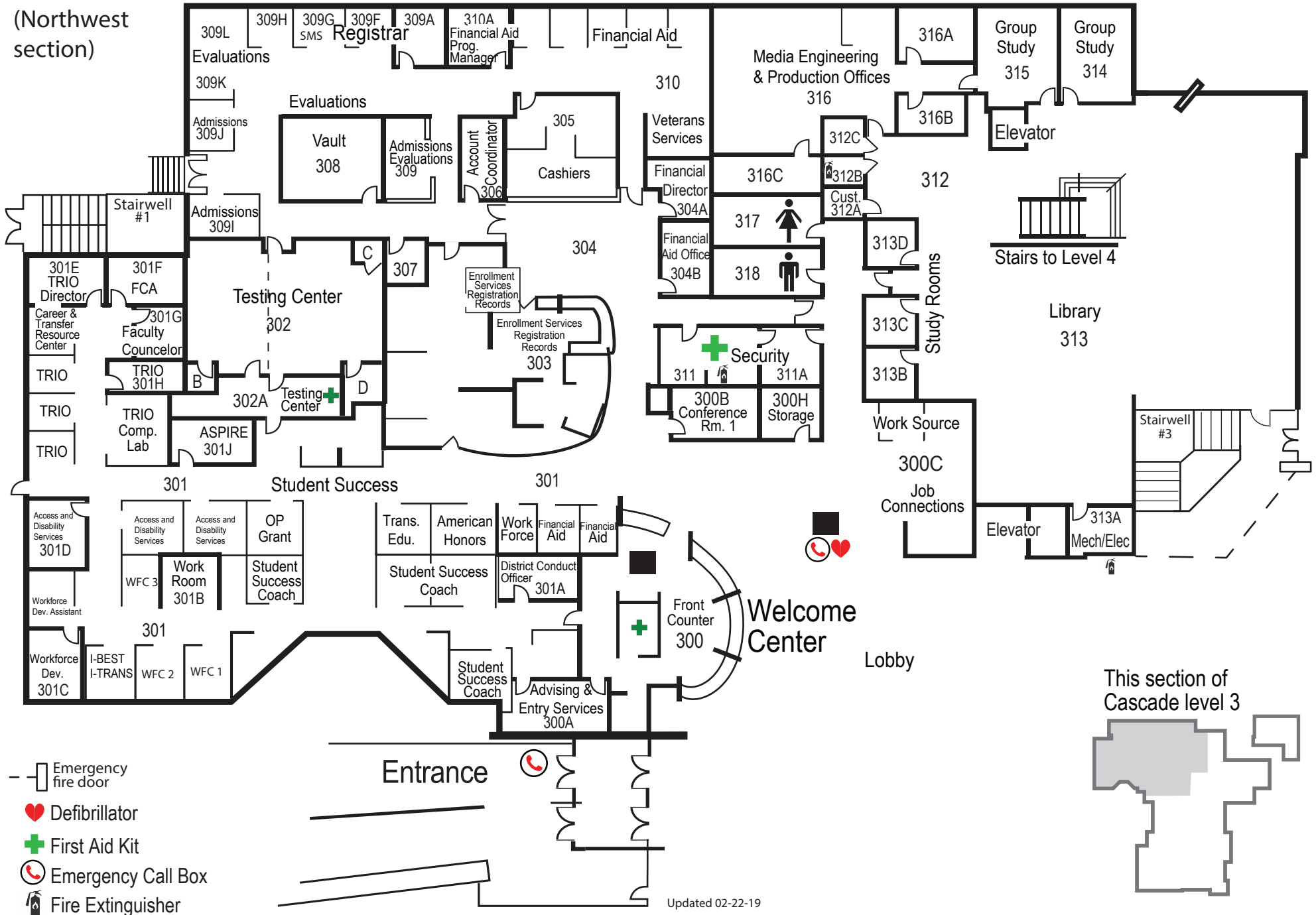

Cascade Building (CAS)

Level 3

(South section)

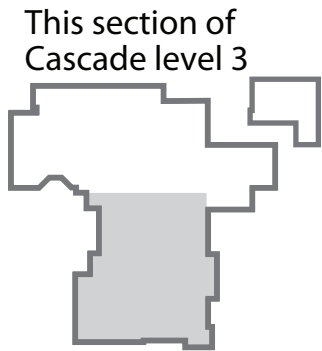
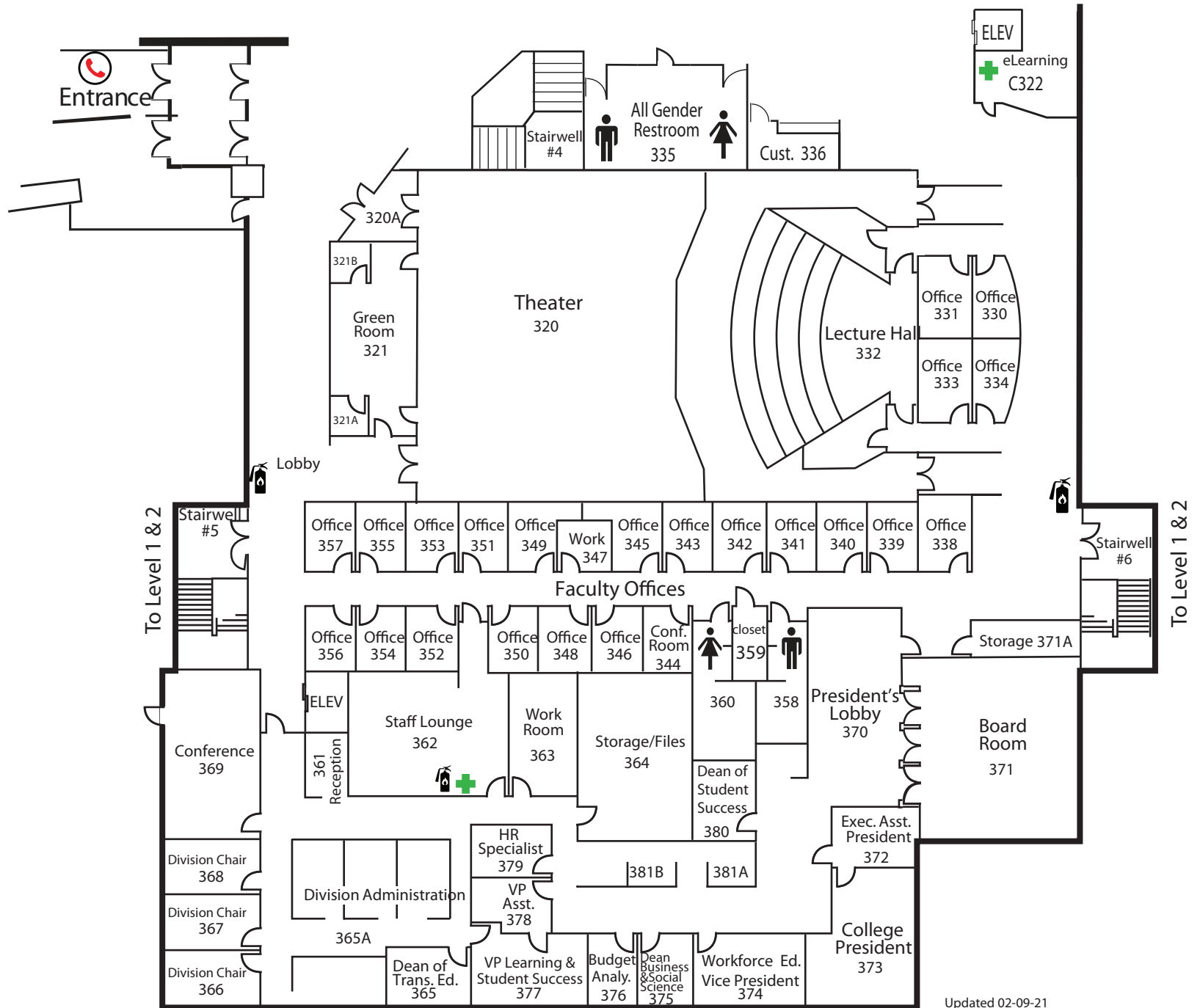

- ♥ Defibrillator
- ✚ First Aid Kit
- ☎ Emergency Call Box
- 🔥 Fire Extinguisher
- ♂ All Gender Restroom

Cascade Building (CAS)

Level 4

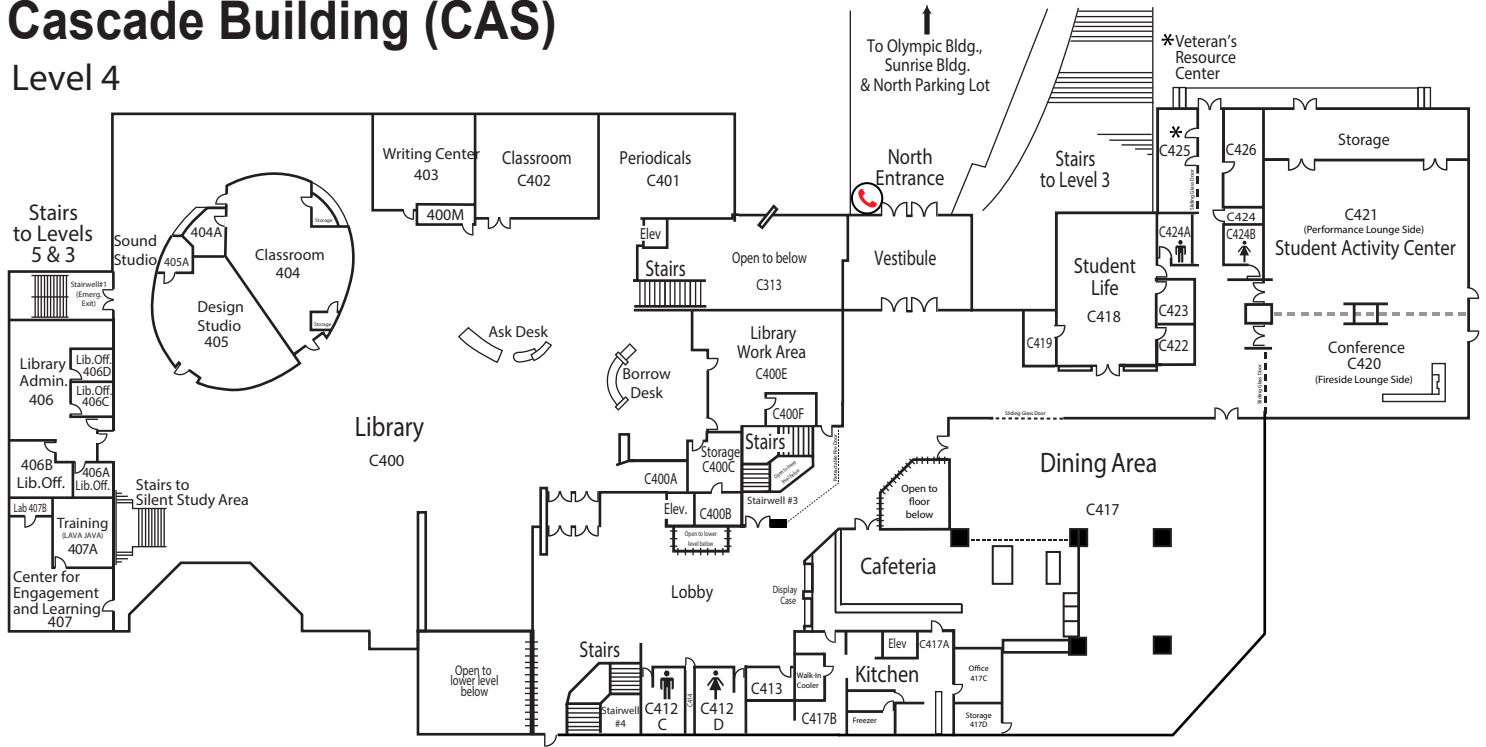

Cascade Building (CAS)

Level 5

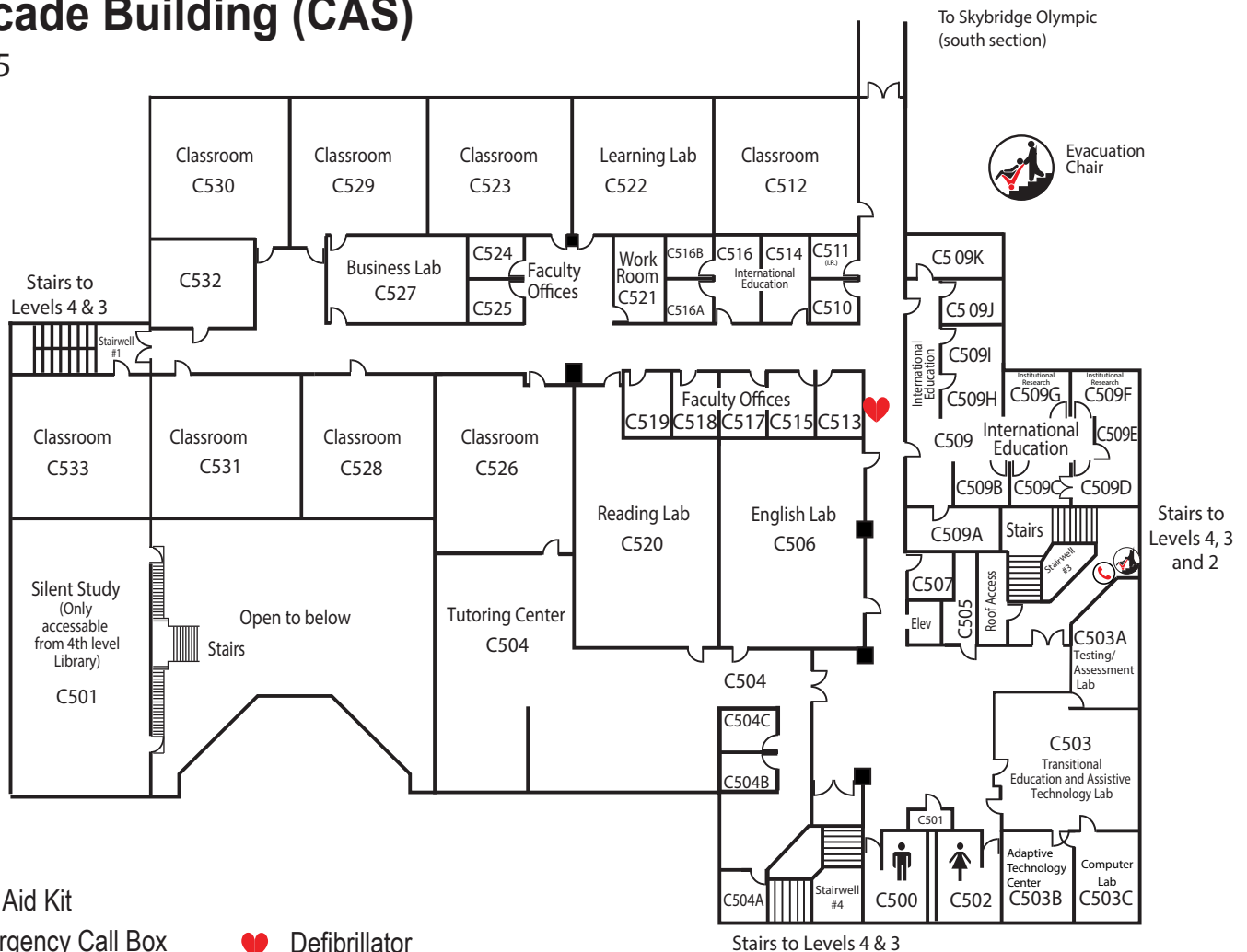

First Aid Kit

Emergency Call Box

Defibrillator

Sliding Door/Wall

Railings

Updated 02-22-19